



Precision machining & finishing Synthetic Diamond Mechanical Range

Taking unpredictability out of mechanical applications

Our range of single crystal and polycrystalline synthetic diamond products is subject to tightly controlled growth conditions and stringent quality control procedures. The result - an engineered material that is highly consistent and has predictable properties and behaviour required for cutting tool, wire drawing, dressing and super-finishing applications.

Our comprehensive mechanical range

| Area | Primary application | Product range | Crystal growth process | |
|------------------------------|--|---|---|---|
| Cutting tools and wear parts | Ultra precision machining acrylics, copper, germanium | MCC PT2 | Single crystal CVD - Colourless (low nitrogen content) |  |
| | Generates very high surface finishes | MCC PT4 | | |
| | Wide-ranging laser cut shape and size for precision machining of MMC and CFRP materials | CDM | Polycrystalline CVD - Opaque (low nitrogen content) |  |
| | Wide-ranging laser cut shape and size for precision machining of MMC, CFRP and woodworking materials | CDE | | |
| | Engineered cutting tools and wear parts for super-finishing burnishing and wire guides | MT L (rectangle) | Single crystal HPHT - Pale yellow (medium nitrogen content) |  |
| | Convenient cut shapes | MT T (triangle) | | |
| MT R (round) | | | | |
| Dressing | Super-finishing and precision machining e.g. precious metals and MMC materials | MXP |  | |
| | | MWS PT4 |  | |
| | MWS PT2 |  | | |
| Wire drawing | Single point, multi-point, blade, roller and rotary dressing | MDL |  | |
| | Chisel dressing / chisel form dressing | MM |  | |
| | Wire drawing of ferrous, non-ferrous precious and refractory metals | MD | Single crystal HPHT - Pale yellow (medium nitrogen content) |  |

| Product family | Key product features | Orientation | Shape availability | Size range | Format |
|-----------------|--|---|---|---|--|
| MONODITE MCC | Premium product having a unique combination of high wear and very high thermal conductivity | 2 pt / {110} plates 4 pt / {100} plates | | Up to 4.0 mm | Polished plates with precise laser cut edges |
| | Polycrystalline CVD with high abrasion resistance and thermal stability. Suitable for dry or MQL machining | Polycrystalline | Primarily rectangles, also squares, triangles and circles* | Available laser cut | Available as grown, lapped or polished |
| | Polycrystalline CVD, electrically conductive to facilitate EDM | Polycrystalline | | Available laser or EDM cut | Available as grown, lapped or polished |
| | Highly engineered polished plates, laser cut to specific dimensions | 4 pt / {100} plates also available in 2 pt / {110} on request | | Typically up to 4 mm edge length and 1.5 mm thickness | Polished plates with precise laser cut edges |
| MONODITE | Near square plates having guaranteed inscribed square | 4 pt / {100} plates | Near square | 2 to 4.5 mm edge length and up to 1.5 mm thickness | Defined by Inscribed Square |
| | Near round plates having guaranteed inscribed circle | | Near round | | Defined by Inscribed Circle |
| | Engineered polished plates benefiting from 2 point orientation | 2 pt / {110} plates | Near rectangular | Typically up to 3 - 4 mm edge length up to 1.5 mm thickness | Polished plates with defined 2 pt / 4 pt directions |
| MONODRESS | Designed for abrasive wear resistance in dressing and parting tool applications | 4 pt / {100} plates | Rectangular logs and squares | Standard sizes 2.5 to 4.5 mm in length | Polished squares or rectangles with precisely laser cut edges |
| | Good thermal stability | | | | |
| | Alternative to natural diamond macles | 3 pt / {111} plates | Triangular / macle shaped. Also available in laser cut triangles up to 3.0 mm edge length | 3.0 to 4.5 mm edge lengths | Polished macle plates |
| MONODIE | Wire drawing die blanks with specific quality controlled inscribed circle Exceptional wear resistance due to 3 pt crystal orientation | 3 pt / {111} plates | Hexagonal polyhedra | 0.5 to 1.80 mm thickness | Polished die blanks having a guaranteed usable inner volume defined as an inscribed circle |

Monodite MCC:

Two-point and four-point direction

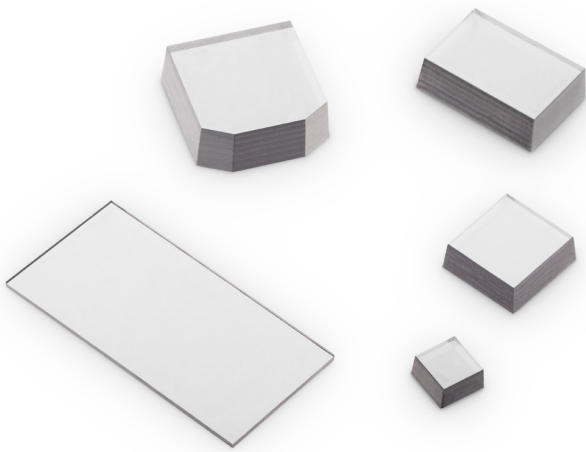

Features

- Unique combination of extreme wear resistance, excellent chip resistance and high thermal conductivity combined with low thermal expansion
- Produced under ultra-high purity conditions
- Colourless

Benefits

- High quality surface finishes on abrasive workpiece materials
- Outperforms natural diamond due to its consistent and predictable material properties
- Offers superior edge quality in ultra-precision machining operations

Tool fabrication

Being an engineered material, MCC is produced in standard sizes that can reduce fabrication times for tool production.

The high chemical purity and consistency also offers potential savings in processing this material. It can be fabricated in to finished tools using standard manufacturing technologies including laser cutting, polishing, brazing and grinding.

For further information please refer to our Processing Guidelines.

Size availability

| Product nomenclature | Dimensions (mm) (length x width x thickness) |
|----------------------|---|
| MCC L453012 | 4.5 x 3.0 x 1.2 |
| MCC L403012 | 4.0 x 3.0 x 1.2 |
| MCC L303012 | 3.0 x 3.0 x 1.2 |
| MCC L302512 | 3.0 x 2.5 x 1.2 |
| MCC L403010 PT4PT2 | 4.0 x 3.0 x 1.0 |

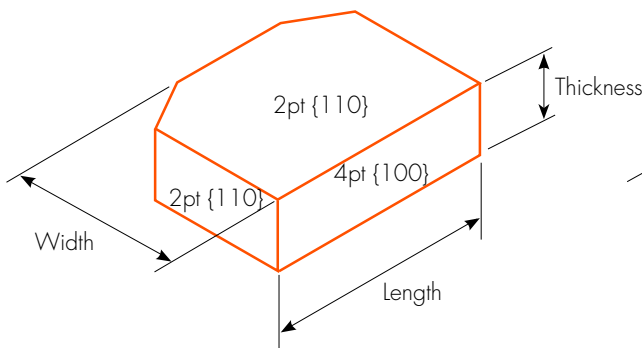

Example of an MCC 2pt product of nomenclature MCC L403012.
Length = 4.0 mm, Width = 3.0 mm and Thickness = 1.2 mm.

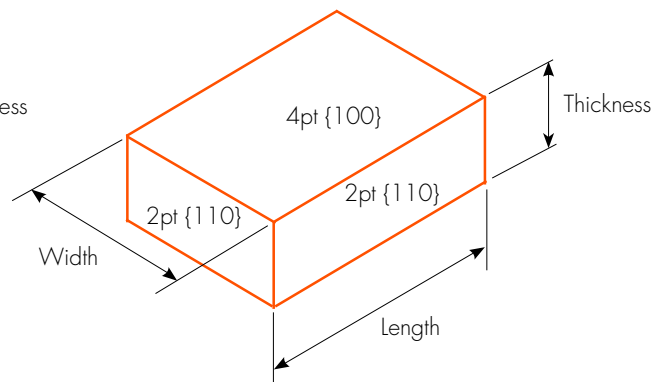

Example of MCC 4pt2pt product nomenclature MCC L403010PT4PT2.
Length = 4.0 mm, Width = 3.0 mm and Thickness = 1.0 mm.

Cvdite: CDM & CDE CVD diamond

Nomenclature examples

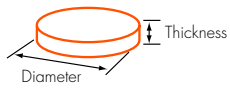

CDE R
CDE R2605-360PL is a CDE grade 'round', 2.6 mm in diameter and 0.5 mm thickness. PL for polished finish

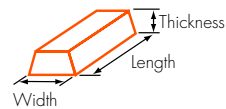

CDE L
CDE L603005PL is a CDE grade, 6.0 mm in length, 3.0 mm wide, 0.5 mm thickness. PL for polished finish

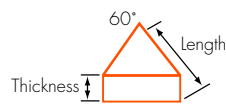

CDE T
CDE T3005-60PL is a CDE grade equilateral triangle having 3.0 mm edge length and 0.5 mm thickness. PL for polished finish

A minimum order charge may be incurred for small volumes of new parts.

Time to reach 0.2 mm flank wear in continuous outside diameter turning of metal matrix composite (AMC225XE (S))

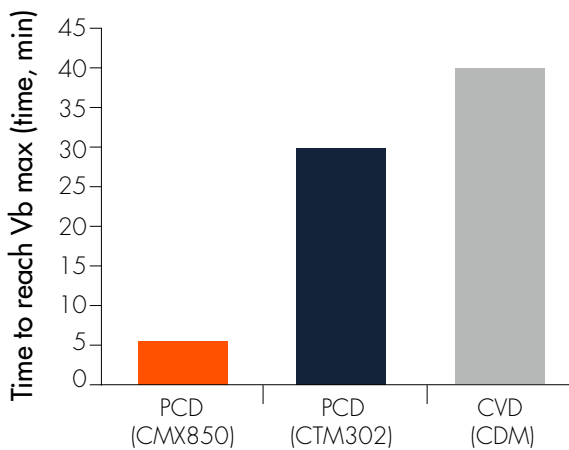

In applications where tool wear is dominated by abrasive wear CVD has been observed to show greater abrasion resistance compared to PCD. Therefore CVD is particularly suitable for highly abrasive continuous turning operations.

Definitions

The standard surface finish has a polished face ($R_a < 100$ nm) and a lapped face ($R_a < 400$ nm) designated with the suffix PL. Unprocessed material is also available-designated NP. The surface finish of NP is either 'as grown' or with any finish to meet the specified thickness.

Features

- High resistance to abrasive wear and high thermal stability
- Chemically inert material
- CDE is electronically conductive

Benefits

- Improved cutting edge quality and better chip flow characteristics
- Reduced friction for wear parts due to polished surface

Suggested application

Cvdite CDE

Cutting tools using electrical discharge machining (EDM) or electrical discharge grinding (EDG)

Cvdite CDM

General purpose cutting tools



Cvdite CDE & CDM

Dry machining of metal matrix composites and high volume fraction glass fibre reinforced materials operating at high temperatures

Tool fabrication

- Typical natural diamond tool fabrication techniques can be applied. Synthesized as flat plates and processed to exact requirements and high standards of the diamond toolmaking industry. Prepared with fine lapped surface preferred for bonding
- Brazing to tungsten carbide substrates can be carried out in a vacuum furnace or reducing gas atmosphere using high temperature active braze alloys
- Highly polished face is recommended for use as the top table or rake face of the tool as beneficial in producing a sharp, chip-resistant cutting edge

Thickness availability

Cvdite (cutting tools)

| CDE | CDM |
|-----------|-----------|
| CDE 05 PL | CDM 05 PL |

CDE 05 PL (0.5 mm thick polished).

Monodite MT: Laser defined shapes

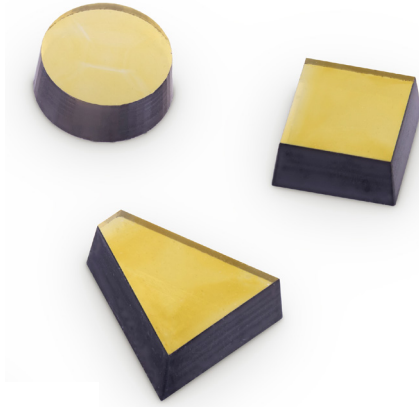

Monodite MT is a highly engineered and tightly specified product.

Suggested application

- Particularly suited to ultra-precision machining such as super-finishing
- Engineered cutting tools and wear parts for super-finishing, burnishing and wire guides
Convenient cut shapes

Features

- Available as 4 pt and 2 pt orientation
- Available in standard cut geometries rectangles, triangles and rounds up to 8 mm maximum edge length and in thickness up to 1.5 mm
- Custom shapes are also available on request
- Produced in standard thickness's 1.0 mm, 1.2 mm, 1.5 mm
- Manufactured by our proprietary high pressure, high temperature synthesis process

Benefits

- Near net sizes facilitates reduced grinding times in tool manufacture
- Laser cut standard geometries allow ease of replacement for conventional Carbide and PCD turning and milling applications
- Available at volume

Available sizes

| Monodite MTL Product nomenclature | Dimensions (mm) (length x width x thickness) | | |
|--------------------------------------|---|--------------|--|
| MT L403010 | 4.0 x 3.0 x 1.0 | | |
| MT L303012 | 3.0 x 3.0 x 1.2 | | |
| MT L302012 | 3.0 x 2.0 x 1.2 | | |
| MT L301512 | 3.0 x 1.5 x 1.2 | | |
| Monodite MTT Product nomenclature | Dimensions (mm) (edge length x thickness) | Angle (°) | |
| MT T3012 - 90 | 3.0 x 1.2 | 90 | |
| MT T3010 - 60 | 3.0 x 1.2 | 60 | |
| Monodite MTT Product nomenclature | Dimensions (mm) (diameter x thickness) | Angle (°) | |
| MT R2512 - 360 | 2.5 x 1.2 | 360 | |
| MT R2012 - 360 | 2.0 x 1.2 | 360 | |

Other sizes available on request including 2 pt and custom products

Monodite MXP: Four-point direction



Our diamond is engineered in our proprietary synthetic process ensuring material consistency and uniformity at volume.

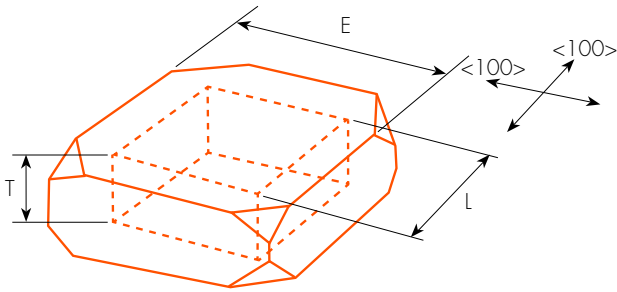

E = Nominal Length T = Nominal Thickness
L = Edge Length of Inscribed Square (at least 75% of E)
{100}, four point stone orientation

Features

- Premium synthetic diamond supplied in a range of specified dimensions from 3 mm to 4.5 mm (four-point direction) in usable edges length
- Manufactured by our proprietary high pressure, high temperature synthesis process

Benefits

- Wide range of standard stock sizes
- Guaranteed inscribed square edge length of 75% minimum of the nominal plate length
- Available at volume

Suggested applications

- General applications
- Super-finishing and precision machining e.g. precious metals and MMC materials

Available sizes

The large range of available sizes gives toolmakers an increased choice and optimises diamond usage.

| Product nomenclature | Nominal length (mm) | Minimum edge length of inscribed square (mm) | Minimum thickness (mm) |
|----------------------|---------------------|--|------------------------|
| MXP L3010 | 3.0 | 2.25 | 1.0 |
| MXP L3012 | 3.0 | 2.25 | 1.2 |
| MXP L3510 | 3.5 | 2.6 | 1.0 |
| MXP L3512 | 3.5 | 2.6 | 1.2 |
| MXP L4010 | 4.0 | 3.0 | 1.0 |
| MXP L4012 | 4.0 | 3.0 | 1.2 |
| MXP L4510 | 4.5 | 3.35 | 1.0 |
| MXP L4512 | 4.5 | 3.35 | 1.2 |

Other sizes available on request, including thickness of up to 1.5 mm.

Monodite MWS: Four-point direction

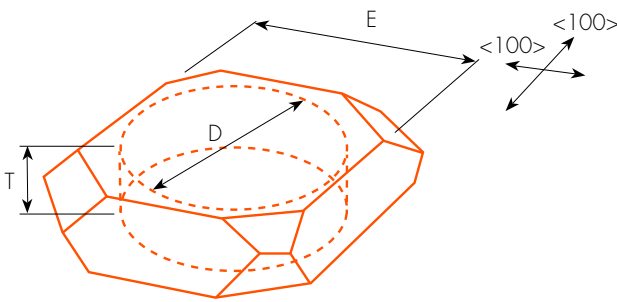
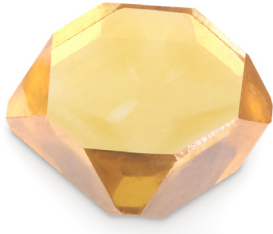

E = Nominal Length T = Nominal Thickness
D = Diameter of Inscribed Circle (at least 80% of E)
{100}, four point stone orientation

Features

- Synthetic single crystal diamond supplied in a range of specific dimensions from 2 mm to 4.5 mm in usual edge length
- Manufactured by our proprietary high pressure, high temperature synthesis process

Benefits

- Wide range of standard stock sizes
- Guaranteed inscribed circle (diameter) of 80% minimum of the nominal plate length
- Available at volume

Suggested applications

- General applications
- Super-finishing and precision machining e.g. precious metals and MMC materials

Available sizes

The large range of available sizes gives toolmakers an increased choice and optimises diamond usage.

| Product nomenclature | Nominal length (mm) | Minimum inscribed circle diameter (mm) | Minimum thickness (mm) |
|----------------------|---------------------|--|------------------------|
| MWS L2008 | 2.0 | 1.6 | 0.8 |
| MWS L2010 | 2.0 | 1.6 | 1.0 |
| MWS L2508 | 2.5 | 2.0 | 0.8 |
| MWS L2510 | 2.5 | 2.0 | 1.0 |
| MWS L3010 | 3.0 | 2.4 | 1.0 |
| MWS L3012 | 3.0 | 2.4 | 1.2 |
| MWS L3510 | 3.5 | 2.8 | 1.0 |
| MWS L3512 | 3.5 | 2.8 | 1.2 |
| MWS L4010 | 4.0 | 3.2 | 1.0 |
| MWS L4012 | 4.0 | 3.2 | 1.2 |
| MWS L4510 | 4.5 | 3.6 | 1.0 |

Other sizes available on request, including thickness of up to 1.5 mm.

Monodite MWS: Two-point direction

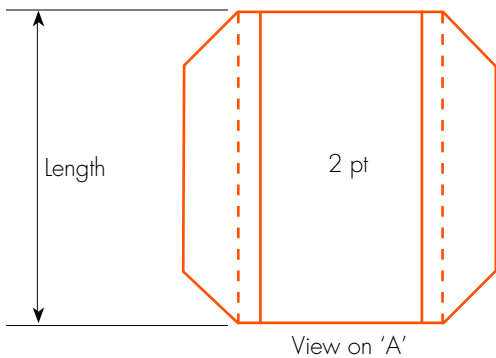
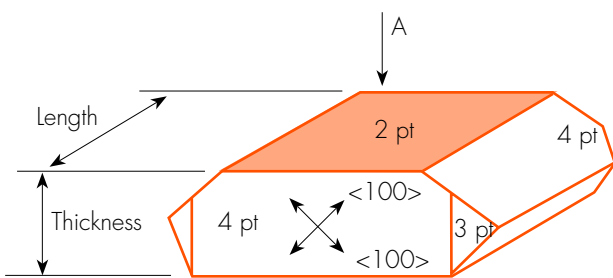

Features

- Synthetic single crystal diamond supplied in as standard sizes
- Guaranteed window in 2 pt and 4 pt directions
- Manufactured by our proprietary high pressure, high temperature synthesis process

Benefits

- Wide range of standard sizes with in a range of specific dimensions from 3.0 to 4.0 mm and 1.0 to 1.2 mm thickness
- With increased abrasive resistance, this format provides an ideal alternative to Two-Point natural diamond plates
- Available at volume

Suggested applications

Particularly suited to ultra-precision machining such as super-finishing in aluminium alloys, acrylic and precious metals.

Large range of available sizes

| Product nomenclature | Edge length (mm) | Thickness (mm) |
|----------------------|------------------|----------------|
| MWS L3010PT2 | 3.0 | 1.0 |
| MWS L3012PT2 | 3.0 | 1.2 |
| MWS L4010PT2 | 4.0 | 1.0 |
| MWS L4012PT2 | 4.0 | 1.2 |

Other sizes available on request, including thickness of up to 1.5 mm.

Monodress MDL: Four-point direction

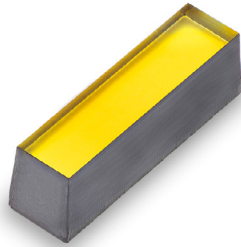

Monodress MDL is supplied in a range of length and square cross sections which are laser cut to exact dimensions to facilitate tool manufacturers.

Simply by rotating the logs through 45° about their central axis, the two point direction can be revealed, offering the option to make a tool with even greater wear resistance. As the MDL has a constant dresser width, no resetting is needed.

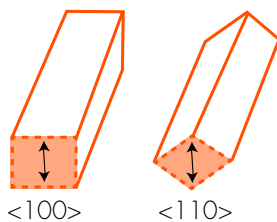

Each product has {100} (four point) orientation on all faces that are easily defined and located with their grinding directions.

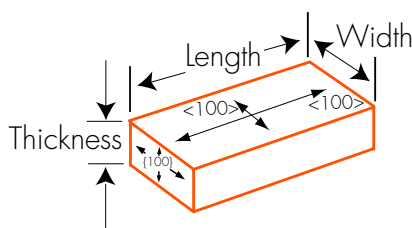

Non-standard dimensions are available by request for this product.

Tool fabrication

Two methods of tool fabrication are suitable for use with Monodress MDL – non-ferrous metal sintering or brazing onto a dresser body using an active braze alloy in a non-oxidising environment. Using diamond grinding, the dressers can be shaped in-situ to make cone, chisel and rounded shapes.

Features

- Supplied as rectangles or square shaped logs in various length
- Excellent thermal stability

Benefits

- Consistent wear from dresser to dresser
- Uniform wear over the entire length of the dresser
- Easy-to-use toolmaking material
- Constant dresser cross-section - no resetting needed

Suggested applications

- All dresser types, for example: single point, multipoint and blade dressing
- Developed to offer high resistance to abrasive wear in dressing and parting tool applications

Size availability

| Product nomenclature | Dimensions (mm) (length x width x thickness) |
|----------------------|---|
| MDL 251212 | 2.5 x 1.2 x 1.2 |
| MDL 251515 | 2.5 x 1.5 x 1.5 |
| MDL 300404 | 3.0 x 0.4 x 0.4 |
| MDL 300606 | 3.0 x 0.6 x 0.6 |
| MDL 300808 | 3.0 x 0.8 x 0.8 |
| MDL 301010 | 3.0 x 1.0 x 1.0 |
| MDL 301212 | 3.0 x 1.2 x 1.2 |
| MDL 301515 | 3.0 x 1.5 x 1.5 |
| MDL 400404 | 4.0 x 0.4 x 0.4 |
| MDL 400606 | 4.0 x 0.6 x 0.6 |
| MDL 400808 | 4.0 x 0.8 x 0.8 |
| MDL 401010 | 4.0 x 1.0 x 1.0 |

Monodress MM 111: Three-point direction

Advantages

- Specific process and quality for use in chisel dressing and chisel form dressing
- All purchased items immediately usable for tools (unlike natural). Size range 3-5 mm edge length
- Consistent 3 pt / {111} orientation
- Available as grown stones but can be laser cut to requirements

Benefits

- A readily available alternative to natural diamond macles
- Economic volume alternative
- Larger and flatter with less rounding and irregularity than natural
- Enhanced and more consistent performance

Suggested application

Engineered for chisel form dressing

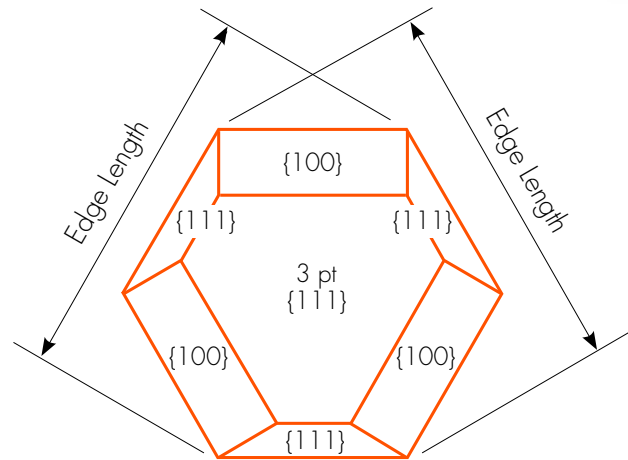

Size availability

| Nomenclature | Edge length | Thickness |
|--------------|-------------|-----------|
| MM 111/3010 | 3.0 | 1.0 |
| MM 111/3012 | 3.0 | 1.2 |
| MM 111/4010 | 4.0 | 1.0 |
| MM 111/4012 | 4.0 | 1.2 |
| MM 111/4510 | 4.5 | 1.0 |
| MM 111/4512 | 4.5 | 1.2 |

Also available as laser cut in thicknesses of up to 1.2 mm.

Monodie MD111: Three-point direction

In every application from electronics to construction, wire drawing dies are the essential tools used to produce the millions of miles of wire drawn. For applications of drawing non-ferrous, ferrous, precious and refractory metals that require ultra-fine finishes, single crystal diamond is the preferred wire drawing material.

The Monodie synthetic single crystal diamond range of wire drawing die blanks, developed by Element Six takes the unpredictability out of wire drawing applications.

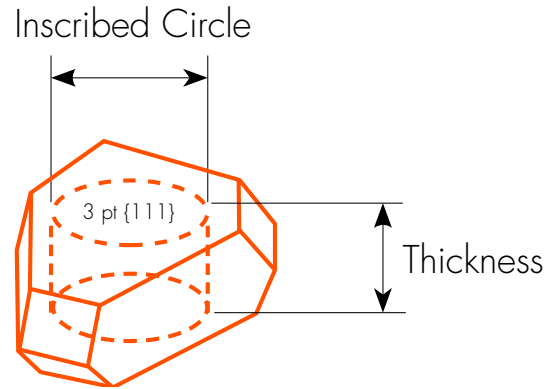

Features

- High level of product quality and consistency
- Exceptional wear resistance
- High thermal stability
- High thermal conductivity

Benefits

- Reliable die life, reduced hole wear distortion and optimal die life due to consistent {111} orientation
- High quality finish on drawn wire
- Consistent tool life

Suggested application

Wire drawing die blank products

Monodie MD111

Monodie MD111 offers the highest level of quality and consistency in wire drawing die blanks. Each diamond blank is produced by a stringently controlled single crystal synthesis process. Properties of the material include exceptional wear resistance resulting from its 3 point {111} crystal orientation. Coupled with excellent thermal conductivity and thermal stability at temperatures up to 1100°C in a non-oxidising environment, the end user benefits are consistent tool life and a high quality finish on the drawn wire.

Size availability

| Nomenclature | Nominal thickness (mm) | Thickness tolerance (mm) | Minimum inscribed circle diameter (mm) |
|--------------|------------------------|--------------------------|--|
| MD111/05 | 0.5 | 0.46 - 0.55 | 0.6 |
| MD111/06 | 0.6 | 0.56 - 0.65 | 0.7 |
| MD111/07 | 0.7 | 0.66 - 0.75 | 0.8 |
| MD111/08 | 0.8 | 0.76 - 0.85 | 0.9 |
| MD111/09 | 0.9 | 0.86 - 0.95 | 1.0 |
| MD111/10 | 1.0 | 0.96 - 1.05 | 1.1 |
| MD111/11 | 1.1 | 1.06 - 1.15 | 1.2 |
| MD111/12 | 1.2 | 1.16 - 1.25 | 1.3 |
| MD111/13 | 1.3 | 1.26 - 1.35 | 1.4 |
| MD111/14 | 1.4 | 1.36 - 1.45 | 1.45 |
| MD111/15 | 1.5 | 1.46 - 1.55 | 1.5 |
| MD111/16 | 1.6 | 1.56 - 1.65 | 1.6 |
| MD111/17 | 1.7 | 1.66 - 1.75 | 1.7 |
| MD111/18 | 1.8 | 1.76 - 1.85 | 1.8 |



Product solutions
to suit your needs
Contact us today





Element Six is a global leader in the design, development and production of synthetic diamond and tungsten carbide supermaterials. Part of the De Beers Group, we employ over 1,900 people. Our primary manufacturing sites are located in the UK, Ireland, Germany, South Africa, and the US.

Since 1959, our focus has been on developing the diamond synthesis process to enable innovative synthetic diamond and tungsten carbide solutions. As well as being the planet's hardest material, diamond's extreme and diverse properties give it high tensile strength, chemical inertness, broad optical transmission and very high thermal conductivity.



Contact us

Europe

Customer Services

T +353 61 460146
E salesorders@e6.com

Americas

T +1 281 364 8080
E ussalesorders@e6.com

Asia Pacific

China

T +86 (0)21 6359 5999
E office.china@e6.com

Japan

T +81 (3)3523 9311
E office.jp@e6.com

e6.com